

# Clamex P Medius 14/10

Pat. pend.

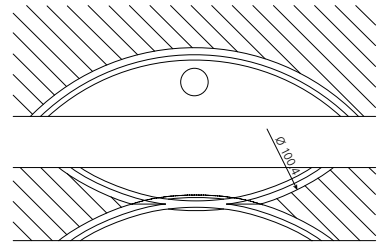
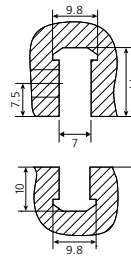
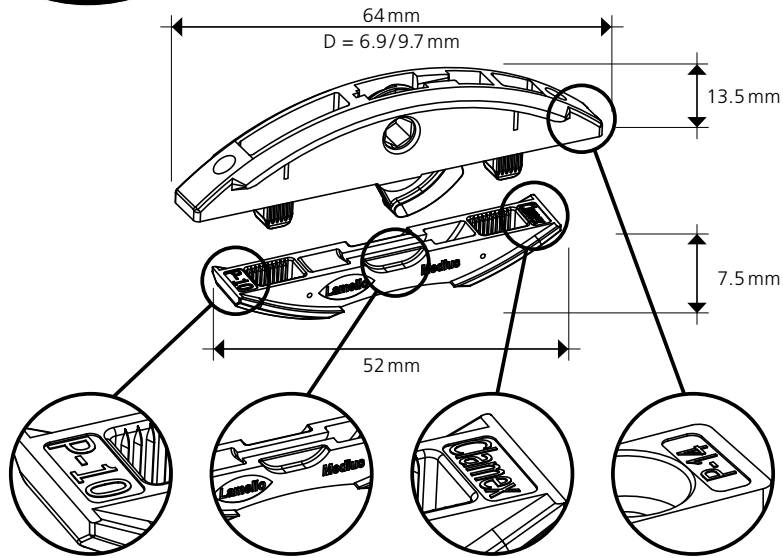

## Zugbruchfestigkeit/ Tensile strength:

Spanplatte/Particle board:

~ 600 N = 60 kg

Buche massiv/Beech massive:

~ 800 N = 80 kg

MDF:

~ 800 N = 80 kg

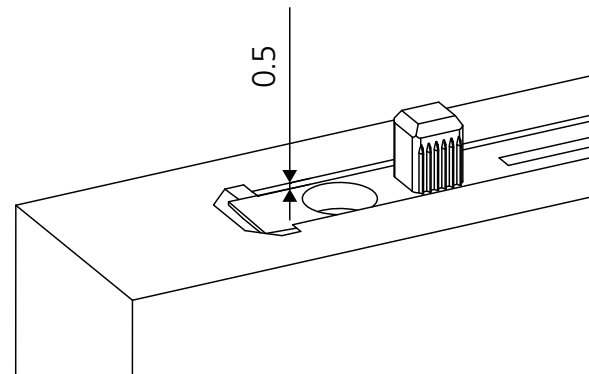
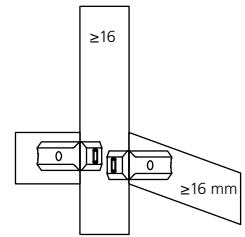
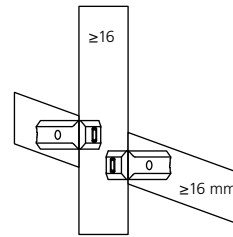
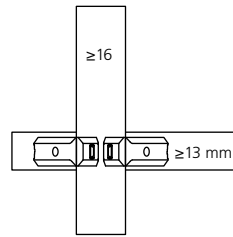
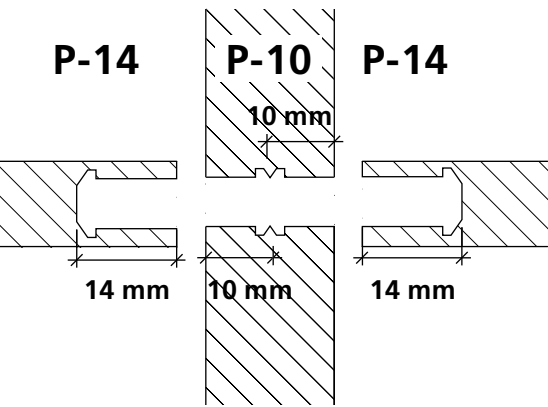
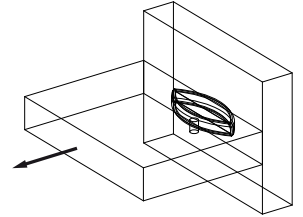

**Scharfe Fräser verwenden**  
Use sharp cutters

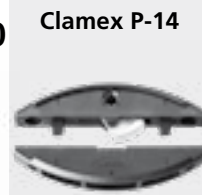
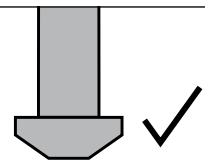
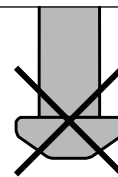

Paar/Pair/ Paire/Paio	Art. No.	Paar/Pair/ Paire/Paio	Art. No.	Paar/Pair/ Paire/Paio	Art. No.
80	145550	80	145415	80	145418
300	145560	300	145425	300	145428
1000	145570	1000	145435	1000	145438

Paar/Pair/ Paire/Paio	Art. No.
80	145370
300	145371

Paar/Pair/ Paire/Paio	Art. No.
80	145334
300	145346
1000	145356

Paar/Pair/ Paire/Paio	Art. No.
80	145372
300	145373
1000	145374

Stück/Piece/ Pièce/Pezzi	Art. No.
P-14 80	145301
300	145302
1000	145303
P-10 80	145304
300	145305

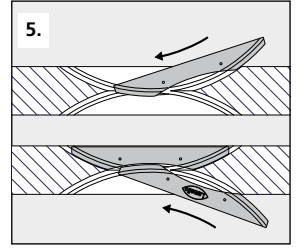
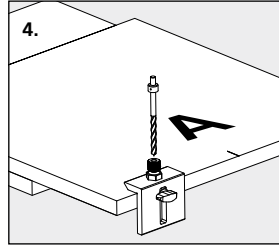
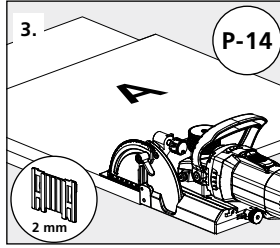
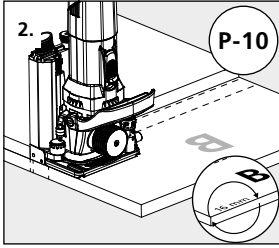
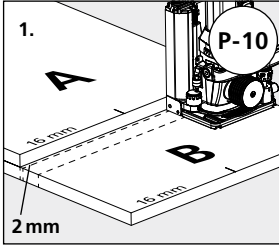
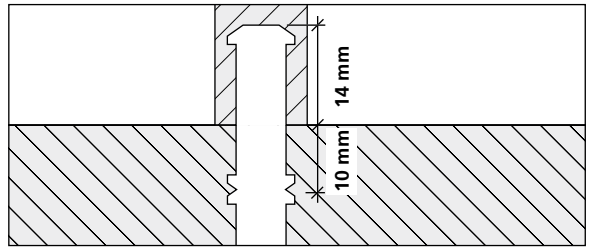
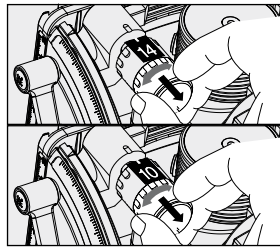
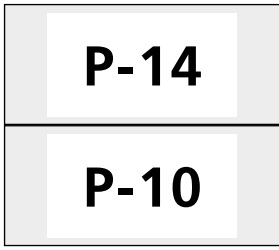
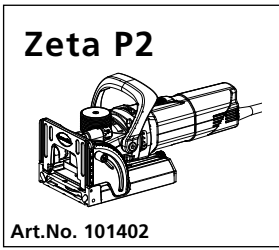

**CNC | Partner network: [www.lamello.com](http://www.lamello.com)**

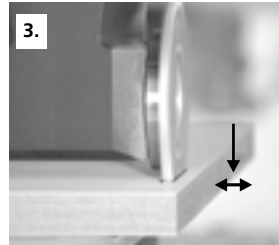
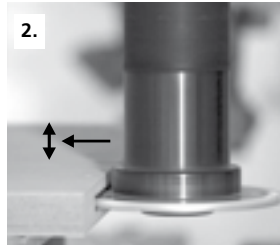
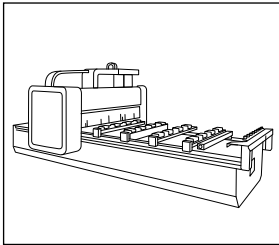

**Art. No. 132142**  
DP, 100.4 x 7 x 30 mm  
4 / 6.6 / DTK 48 mm  
\* Passend zu allen aufgeführten Fräsdornen  
Suitable for all cutter arbors listed

**Art. No. 132143**  
DP, 100.4 x 7 x 40 mm  
4 / 5.5 / DTK 52 mm

**Art. No. 132144**  
DP, 100.4 x 7 x 16 mm  
4 / 5.5 / DTK 28 mm

\* **Art. No. 132150**  
20 x 50, L = 102 mm

\* **Art. No. 132151**  
25 x 60, L = 102 mm

\* **Art. No. 132152**  
16 x 50, L = 85 mm

\* **Art. No. 132153**  
16 x 55, L = 68 mm

\* **Art. No. 132154**  
16 x 50, L = 85 mm, mit Spannfläche (2°-schräg)/with clamping surface (2°-angle)

\* **Art. No. 132155**  
20 x 50, L = 85 mm, mit Spannfläche (2°-schräg)/with clamping surface (2°-angle)

**Abdeckkappen / Cover caps**  
100 Stück / 100 Pieces

90°

45°

RAL	Art. No.	RAL	Art. No.
9010	335280	9010	335380
9011	335281	9011	335381
1014	335282	1014	335382
1011	335283	1011	335383
8007	335284	8017	335384
8017	335289	7022	335388
9002	335285		
7035	335286		
7040	335287		
7031	335288		
7022	335298		

**Art. No. 131556**  
Ø = 6 / 10 mm  
l = 100 / 35 mm

**Art. No. 271945**  
Ø = 4 mm  
75 x 55 mm

**Art. No. 271945A**  
Ø = 4 mm  
120 x 50 mm

**Art. No. 251993**  
Ø = 4 mm  
flexibel

