

Clamex P-14

Pat. pend.

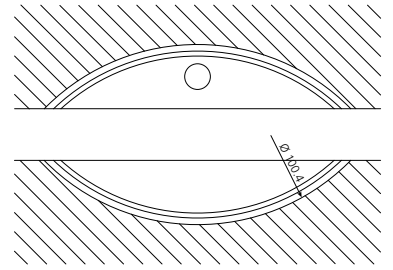
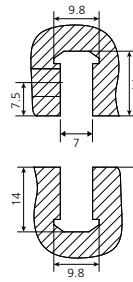
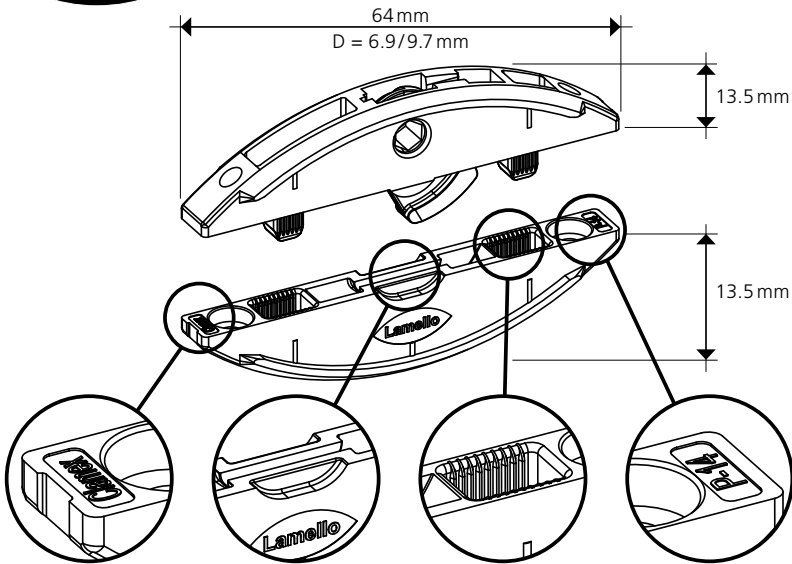

Zugbruchfestigkeit/ Tensile strength:

- Spanplatte/Particle board:
~ 800 N = 80 kg
- Buche massiv/Beech massive:
~ 1000 N = 100 kg
- MDF:
~ 900 N = 90 kg

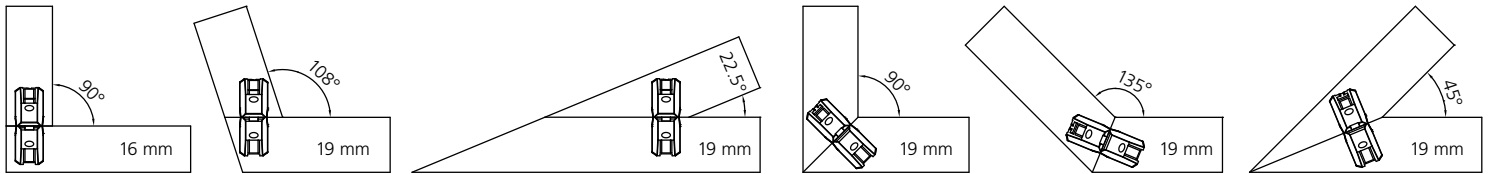
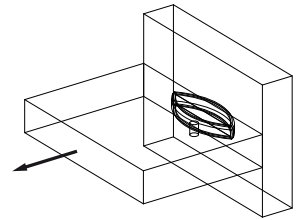

P-System Konfigurator auf unserer Webseite



P-system configurator on our website www.lamello.com/p-system-configurator

P-14

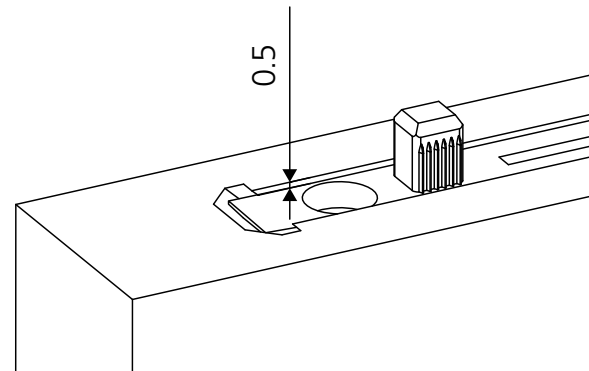
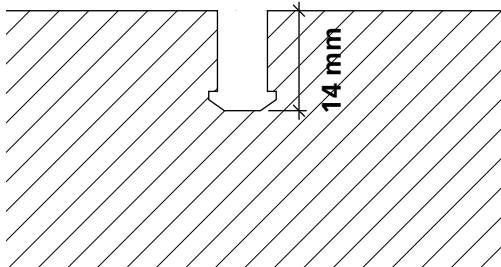

Scharfe Fräser verwenden
Use sharp cutters

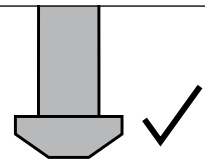
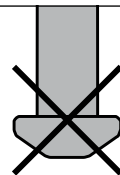

Divario P-18



Paar/Pair/ Paire/Paio	Art. No.
80	145550
300	145560
1000	145570

Tenso P-14



Paar/Pair/ Paire/Paio	Art. No.
80	145415
300	145425
1000	145435

Tenso P-10

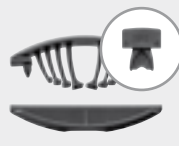

Paar/Pair/ Paire/Paio	Art. No.
80	145418
300	145428
1000	145438

Clamex P Medius 14/10



Paar/Pair/ Paire/Paio	Art. No.
80	145370
300	145371

Clamex P-14



Paar/Pair/ Paire/Paio	Art. No.
80	145334
300	145346
1000	145356

Clamex P-10



Paar/Pair/ Paire/Paio	Art. No.
80	145372
300	145373
1000	145374

Bisco P-14 Bisco P-10



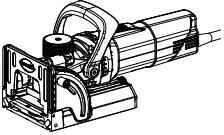

Stück/Piece/ Pièce/Pezzi	Art. No.
P-14 80	145301
300	145302
1000	145303
P-10 80	145304
300	145305

Zeta P2

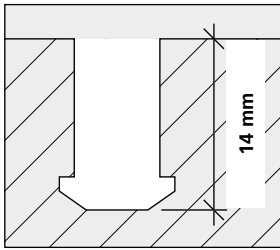
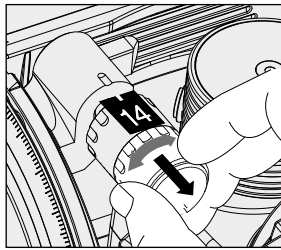

Art.No. 101402

P-14

Art.No. 132140 (Diamant)
DP, Ø 100.4 × 7 × 22 mm

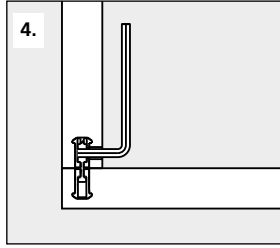
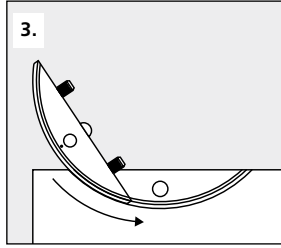
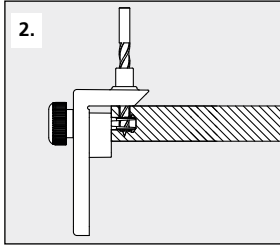
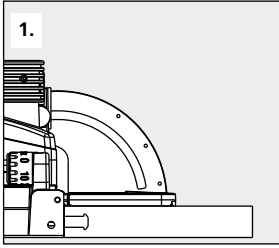

Art.No. 132141
HW, Ø 100.9 × 7 × 22 mm



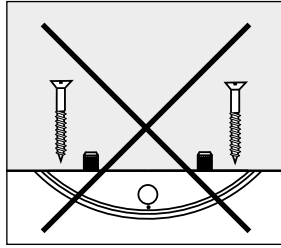

Art. No. 131506
Ø = 6 mm

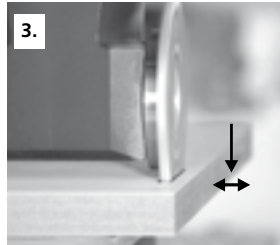
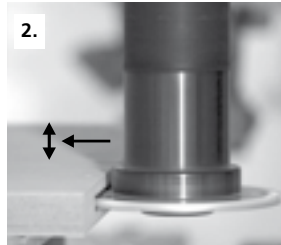
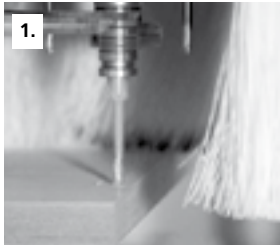
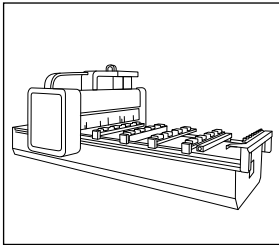

Art.No. 125344

CNC | Partner network: www.lamello.com



Art. No. 132142
DP, 100.4 × 7 × 30 mm
4 / 6.6 / DTK 48 mm
* Passend zu allen aufgeführten Fräsdornen
Suitable for all cutter arbors listed



Art. No. 132143
DP, 100.4 × 7 × 40 mm
4 / 5.5 / DTK 52 mm

Art. No. 132144
DP, 100.4 × 7 × 16 mm
4 / 5.5 / DTK 28 mm

* **Art. No. 132150**
20 × 50, L = 102 mm

* **Art. No. 132151**
25 × 60, L = 102 mm

* **Art. No. 132152**
16 × 50, L = 85 mm

* **Art. No. 132153**
16 × 55, L = 68 mm

* **Art. No. 132154**
16 × 50, L = 85 mm, mit Spannfläche (2°-schräg)/with clamping surface (2°-angle)

* **Art. No. 132155**
20 × 50, L = 85 mm, mit Spannfläche (2°-schräg)/with clamping surface (2°-angle)



Abdeckkappen / Cover caps
100 Stück / 100 Pieces

90°

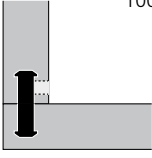

RAL	Art. No.
9010	335280
9011	335281
1014	335282
1011	335283
8007	335284
8017	335289
9002	335285
7035	335286
7040	335287
7031	335288
7022	335298

45°

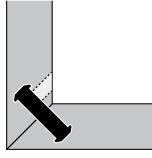

RAL	Art. No.
9010	335380
9011	335381
1014	335382
1011	335383
8017	335384
7022	335388



Art. No. 131556
Ø = 6 / 10 mm
l = 100 / 35 mm



Art. No. 271945
Ø = 4 mm
75 × 55 mm
Art. No. 271945A
Ø = 4 mm
120 × 50 mm



Art. No. 251993
Ø = 4 mm
flexibel

