



Paslode[®]
Impulse[®]

PPN35Ci - PPN50Ci





Paslode
Impulse



= 1250
(-5°C)





Paslode
Impulse



PPN35Ci
Ø 3.4 mm
L = 35 mm
Hardened Twisted Nails



PPN50Ci
Ø 4 mm
L = 35 - 40 - 50 mm
Hardened Ring Nails



Paslode
Impulse



= 13000 max



15 mn = 2500 max
60 mn = 10000 max
90 mn = 13000 max
2 mn = 200

○ ○ ○ ● 100%
○ ○ ● 75%
○ ● 50%
● 25%

● 0 → 300



BANG !

- 15 °C → + 49 °C

1000/hour
3300/day

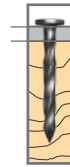

MAX 2 mm

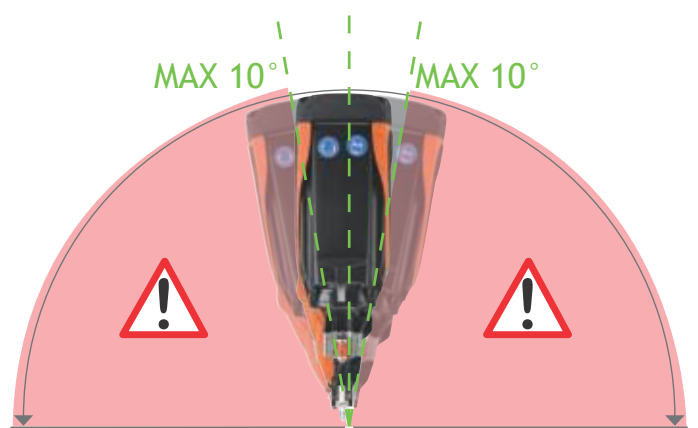
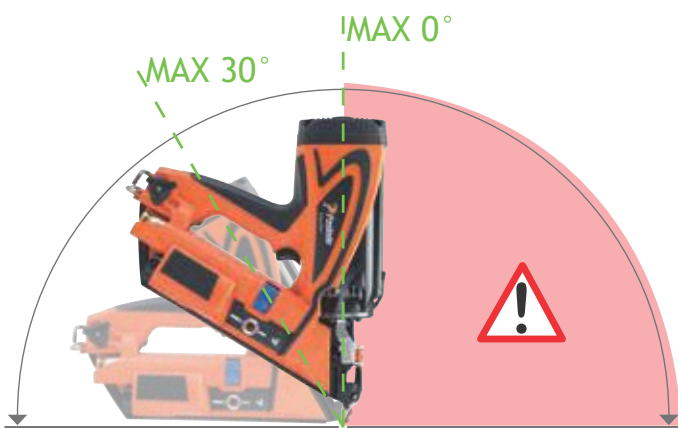
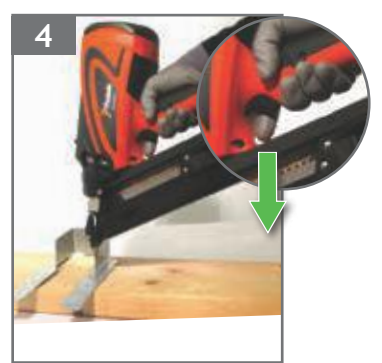
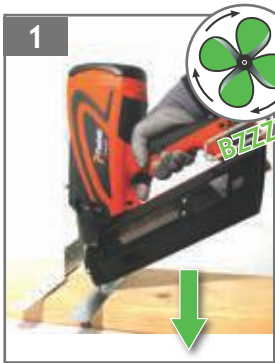

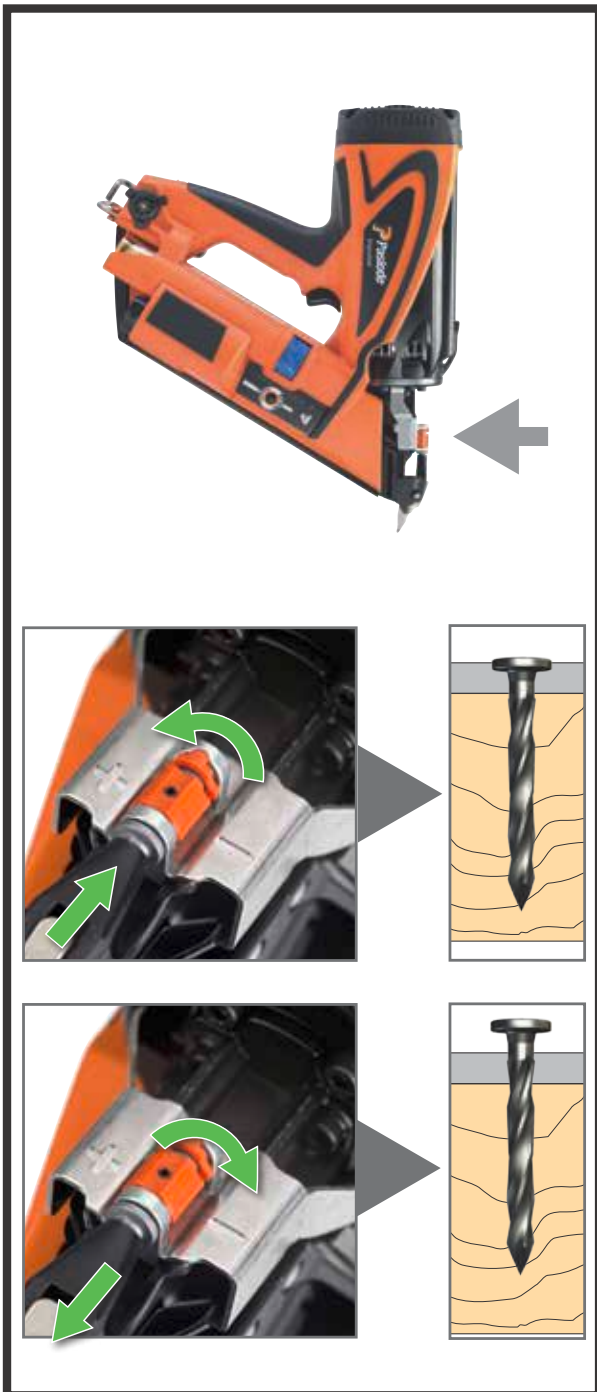

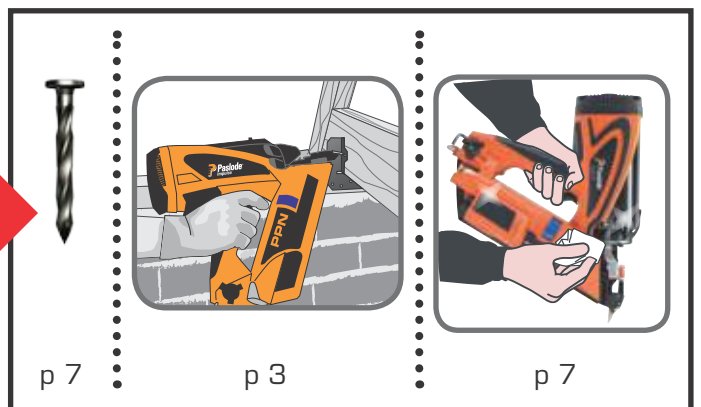
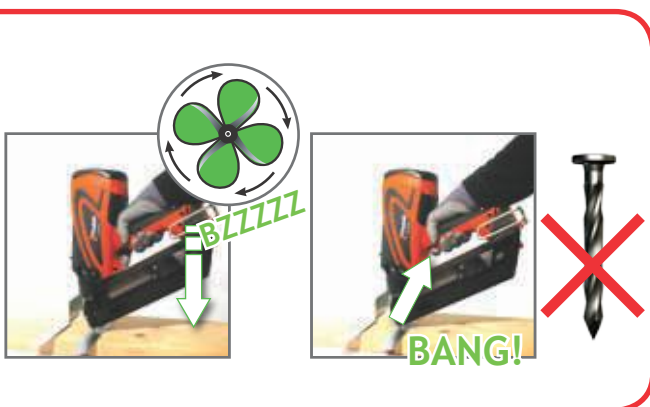
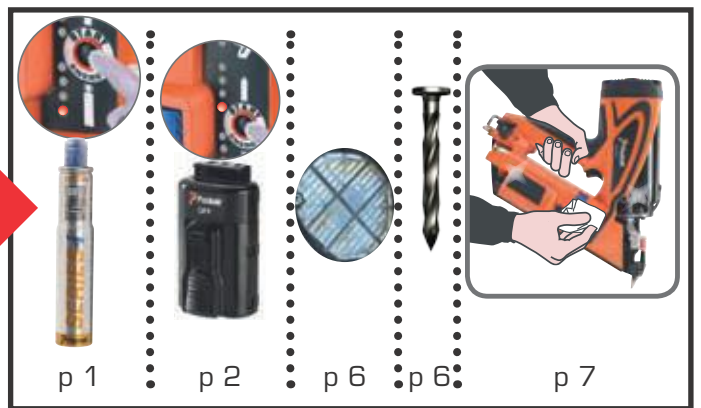
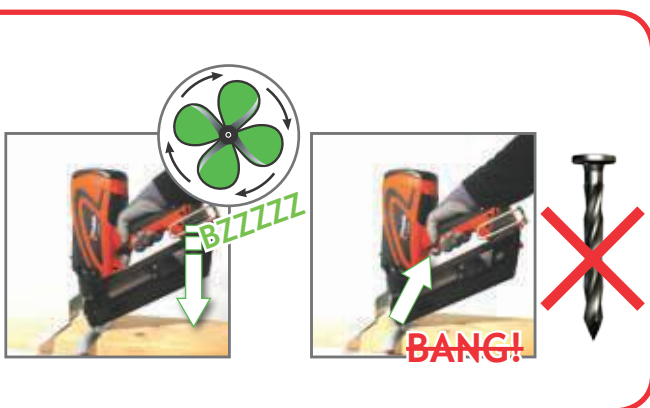
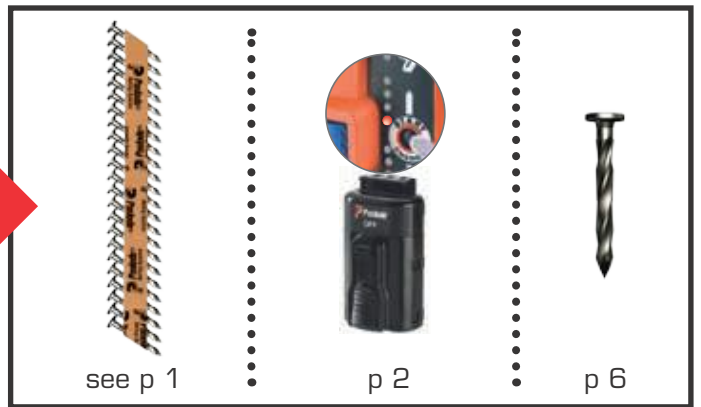
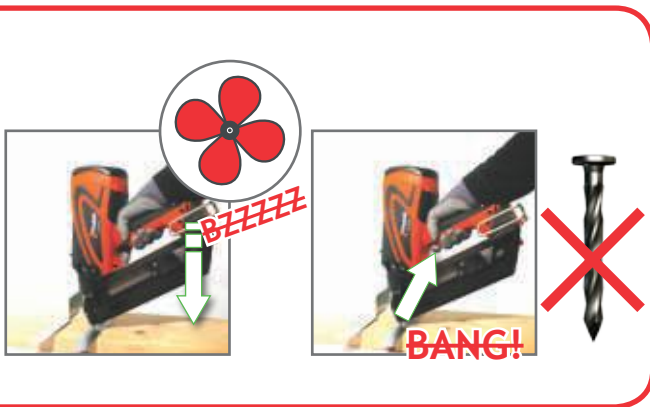
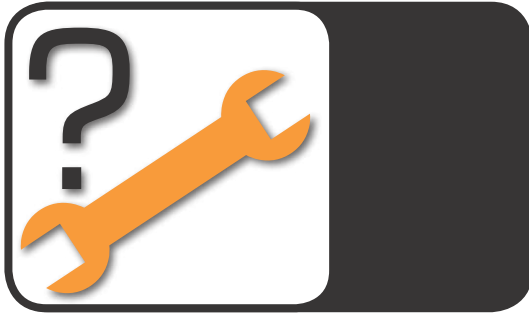

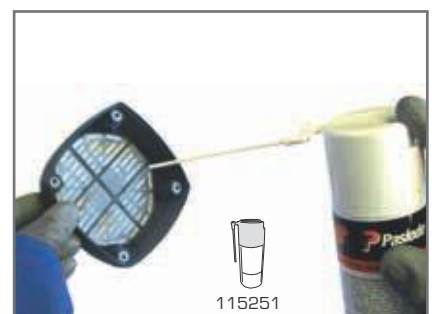
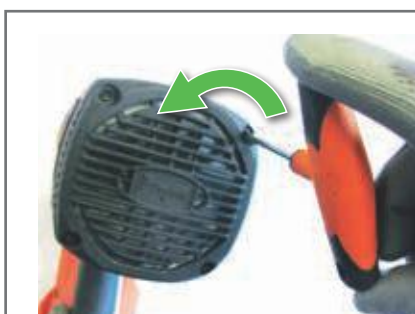
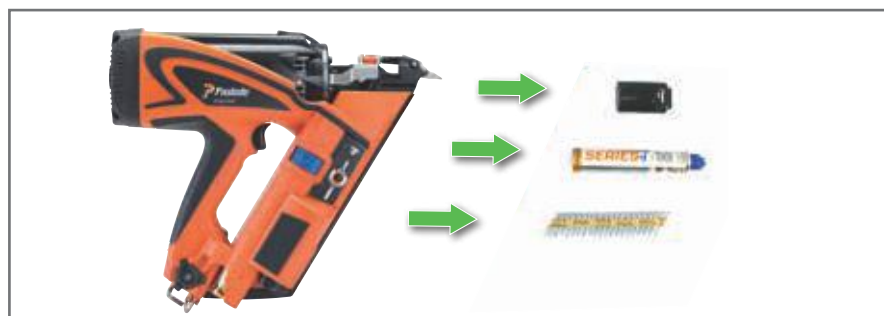
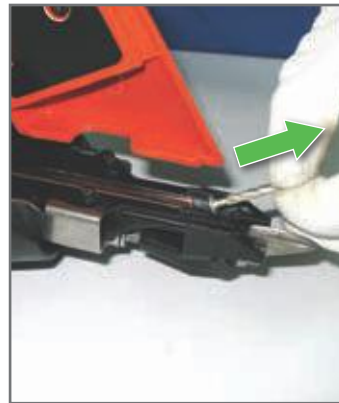

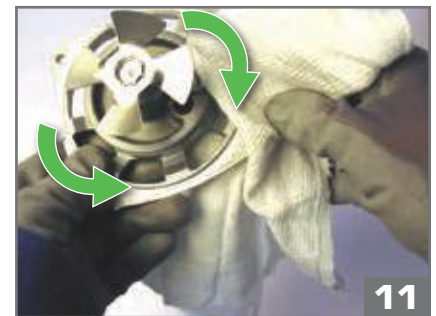
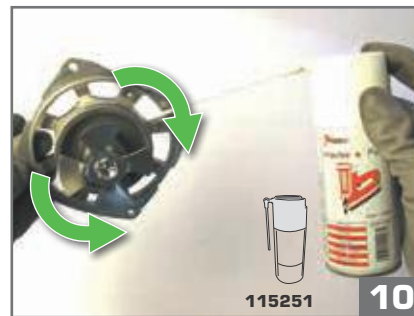
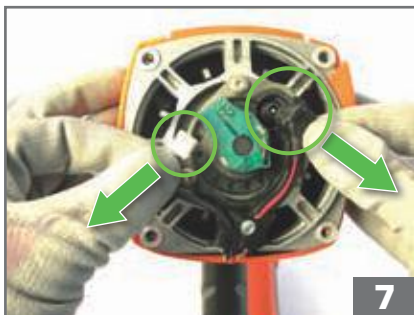
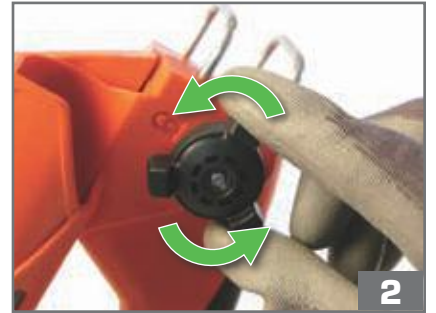
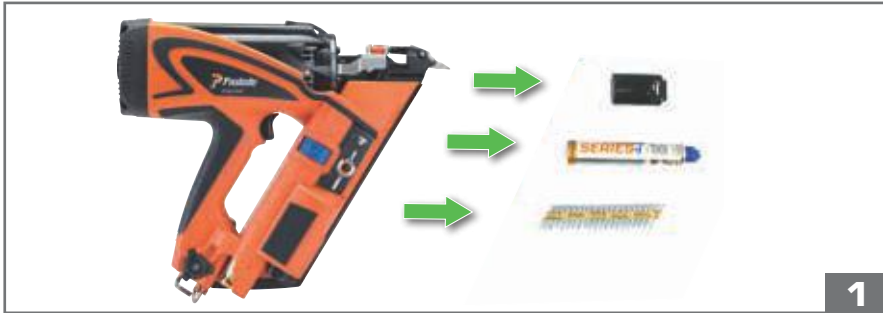
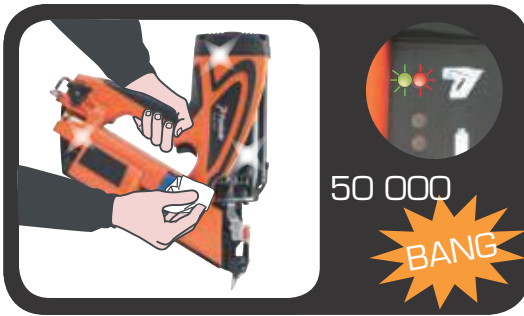

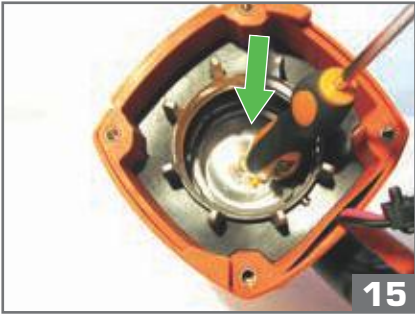

15



115251

16

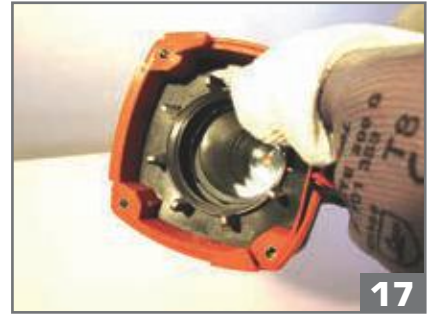

17

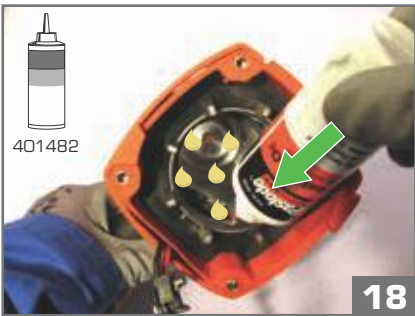

401482

18

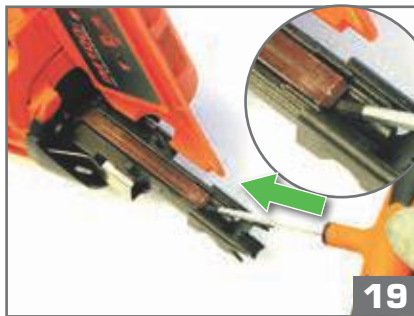

19

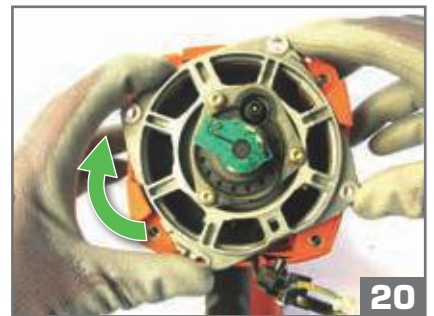

20

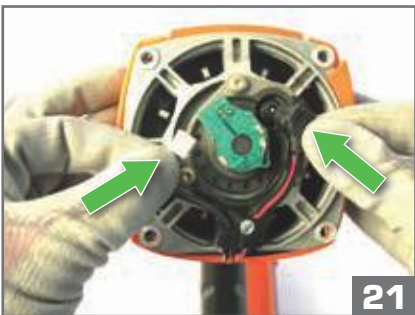

21

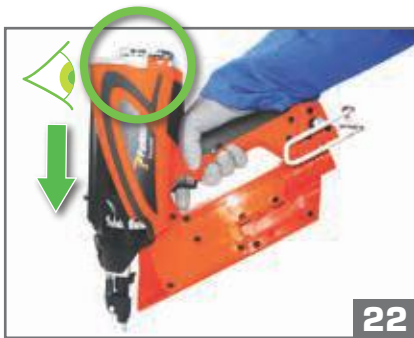

22



OK



NO

24



25

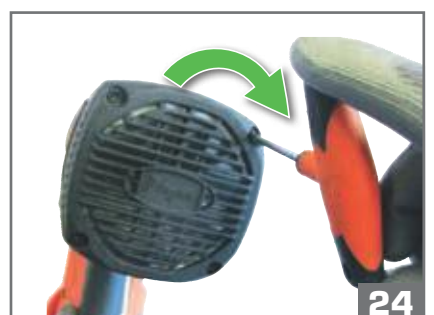

26

RESET



> 10s

Notes



Notes

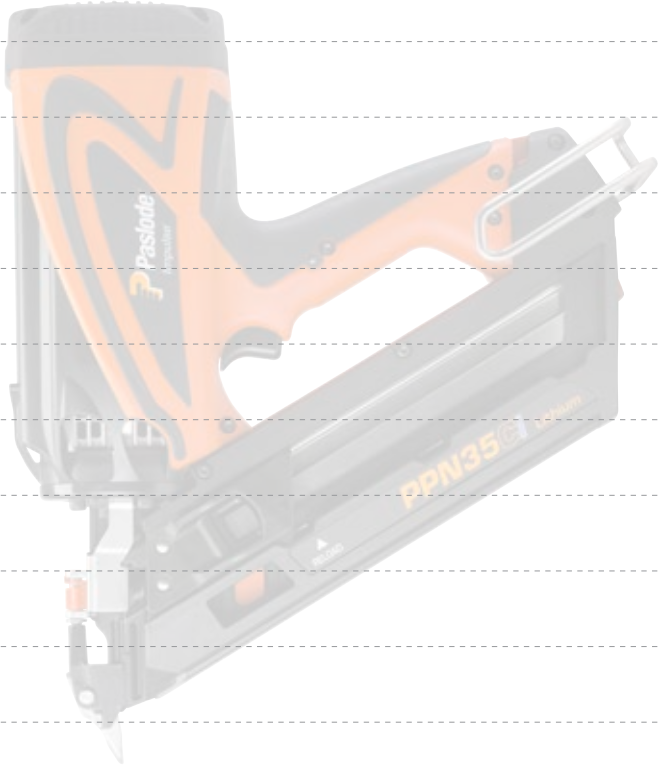



Route de Lyon - BP 104
 F-26501 Bourg-lès-Valence
 Cedex - FRANCE

Réalisation Made in France - Photos non contractuelles



018185-2
 09/15